

# Model No.:T900F

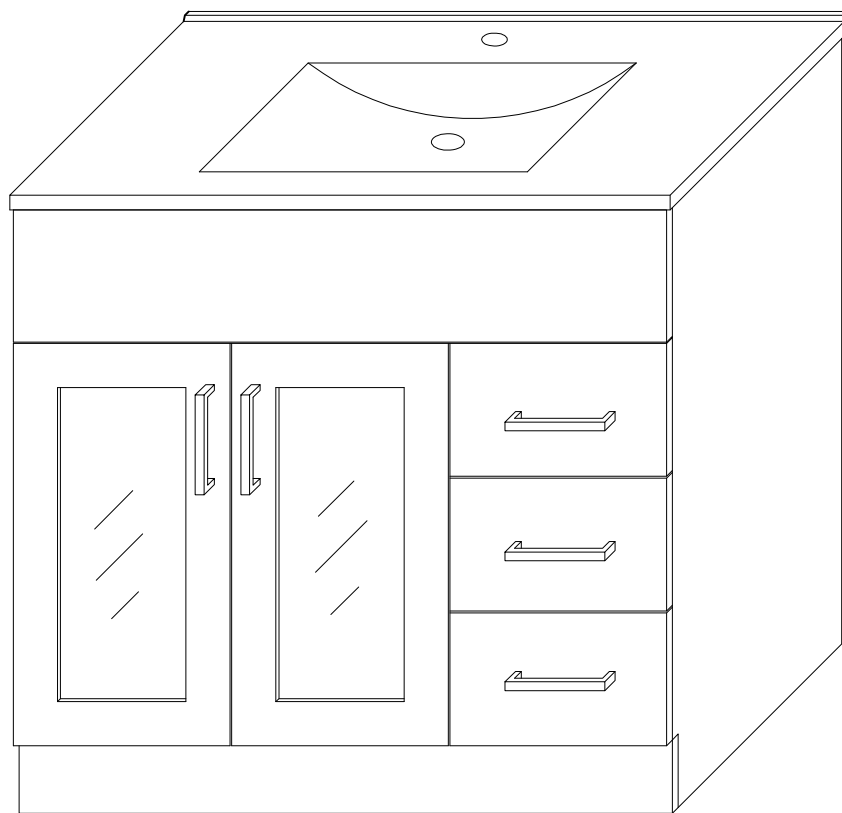

**THE LENNOX™  
BATHROOM**

*Ideas for life style*

Auckland Ph:09 2710168















Hamilton Ph:07 8477722

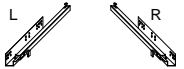







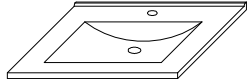

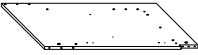
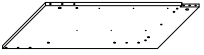

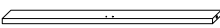

Christchurch Ph:03 3488885

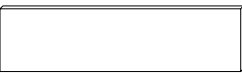
Dunedin Ph:03 4775885

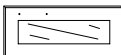
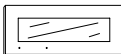
Nelson Ph: 03 35488858

Online Order: [www.lennoxbathroom.nz](http://www.lennoxbathroom.nz)

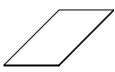
NO.	Schema	PCS	Dimension(mm)
①		22	$\phi 8 \times 30\text{mm}$
②		51	$\phi 6 \times 32\text{mm}$
③		51	
④		38	
⑤		2	
⑥		2	
⑦		48	$M4 \times 14\text{mm}$
⑧		3	
⑨		8	$M4 \times 12\text{mm}$
⑩		2	
⑪		5	
⑫		10	$M4 \times 18\text{mm}$
⑬		6	$M4 \times 25\text{mm}$
⑭		4	
⑮		4	
⑯		1	

NO.	Schema	PCS	Dimension(mm)
1		1	830×435×16
2		1	830×435×16
3		1	525×367×16
4		1	857×50×16
5		1	857×160×16
6		1	857×50×16
7		1	857×160×16
8		1	857×384×16
9		1	890×180×15
10		1	890×100×15
11		1	548×295×15
12		1	548×295×15
13		3	350×100×16
14		3	350×100×16
15		3	229×100×16
16		3	229×100×16
17		3	241×330×2.7
18		3	295×181×15
19		1	570×360×16

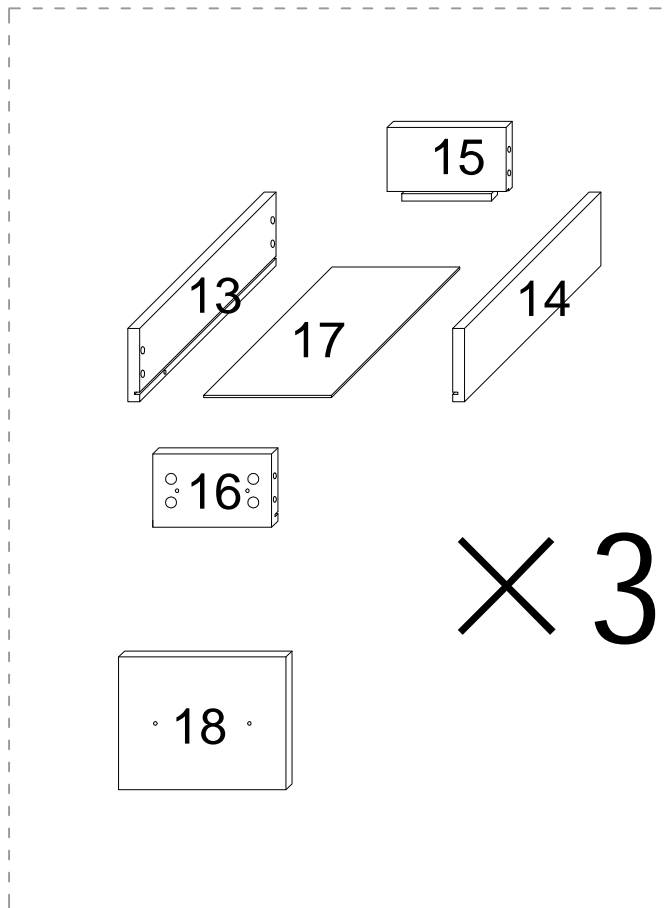
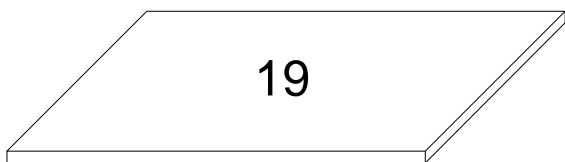
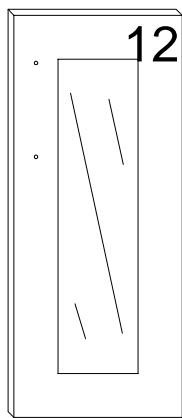
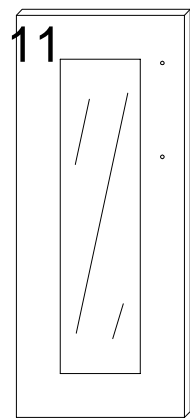
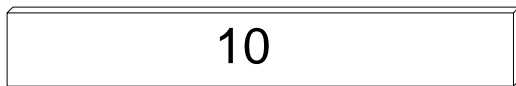
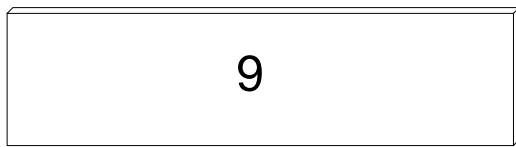
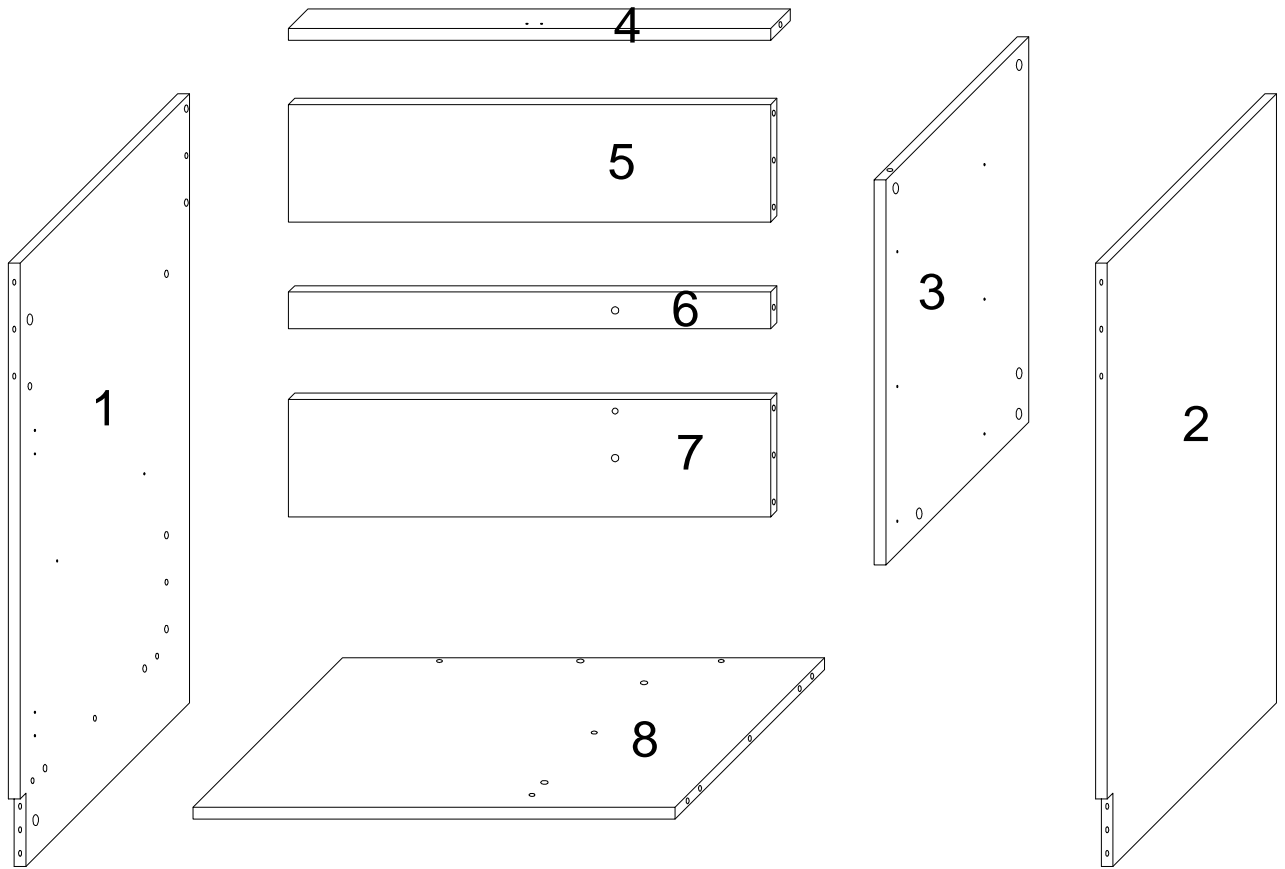

× 3

# 1

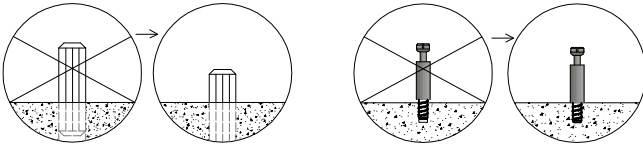
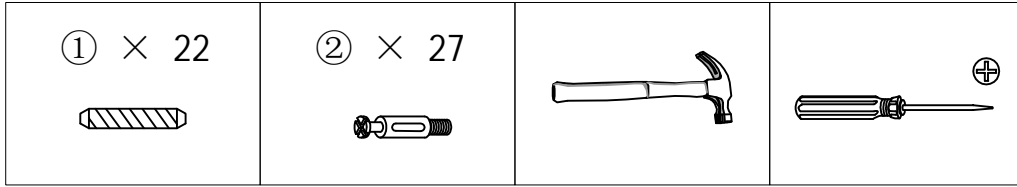

$\textcircled{1} \times 3$

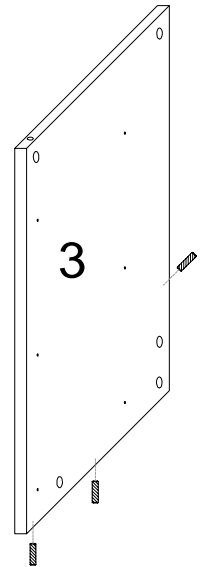

3

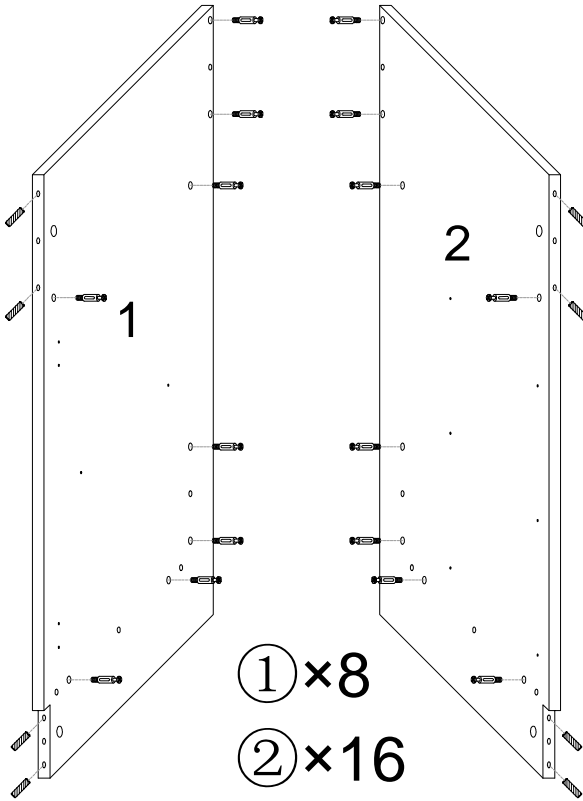

2

$\textcircled{1} \times 8$

$\textcircled{2} \times 16$

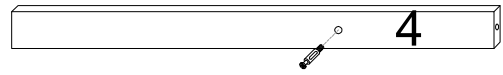

4

$\textcircled{2} \times 1$



5

$\textcircled{1} \times 2$

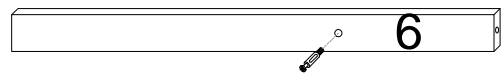

6

$\textcircled{2} \times 1$

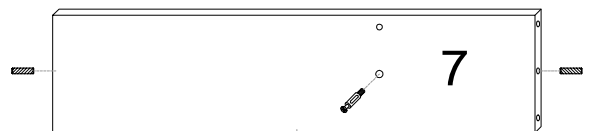

7

$\textcircled{1} \times 3$

$\textcircled{2} \times 1$



9

$\textcircled{2} \times 2$

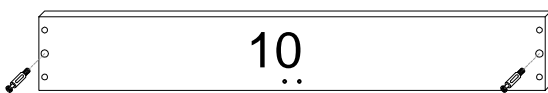

10

$\textcircled{2} \times 2$

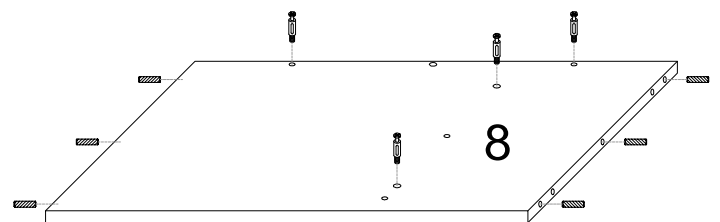





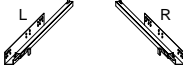

8

$\textcircled{1} \times 6$

$\textcircled{2} \times 4$

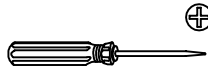
# 2

$\textcircled{8} \times 3$ 	$\textcircled{7} \times 20$  M4 × 14	$\textcircled{3} \times 2$ 	$\textcircled{4} \times 2$ 	
$\textcircled{10} \times 2$ 	$\textcircled{9} \times 4$  M4 × 12			

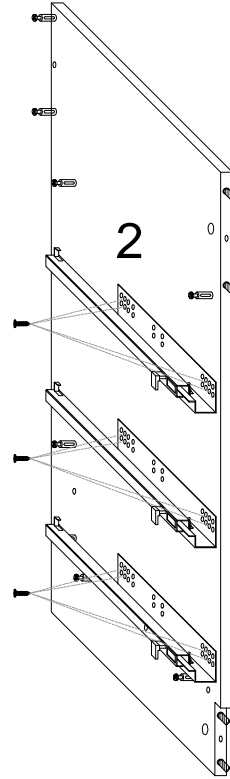
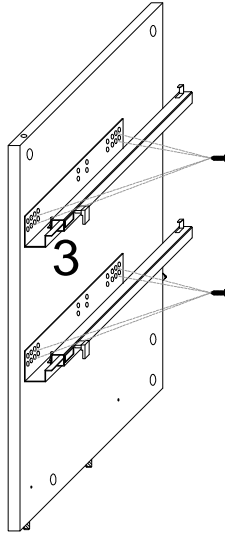

- $\textcircled{8} \text{L} \times 2$
- $\textcircled{8} \text{R} \times 3$
- $\textcircled{7} \times 20$

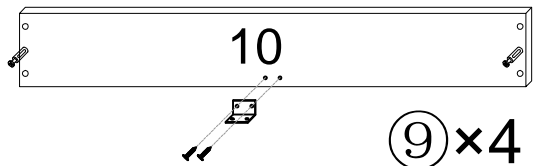
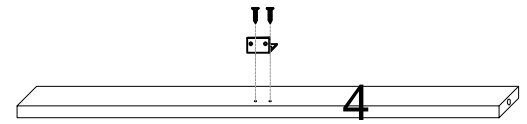
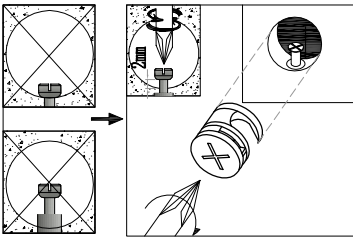



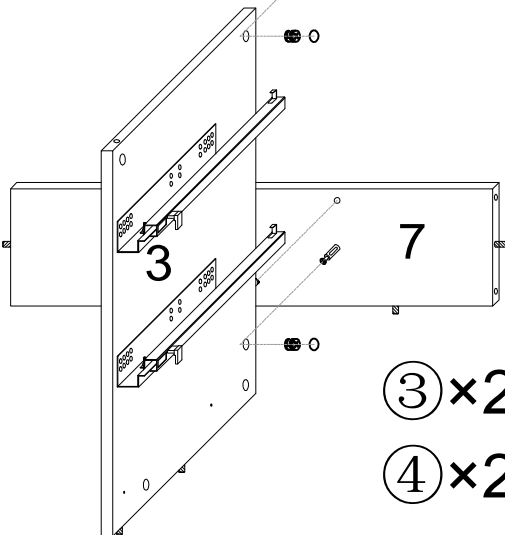
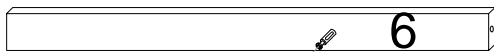

- $\textcircled{9} \times 4$
- $\textcircled{10} \times 2$



- $\textcircled{3} \times 2$
- $\textcircled{4} \times 2$

# 3

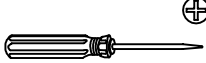
$\textcircled{3} \times 21$ 	$\textcircled{4} \times 20$ 	$\textcircled{8}L \times 1$ 	$\textcircled{7} \times 4$  M4 × 14	
------------------------------------------------------------------------------------------------------------------	------------------------------------------------------------------------------------------------------------------	------------------------------------------------------------------------------------------------------------------	------------------------------------------------------------------------------------------------------------------------------	-------------------------------------------------------------------------------------

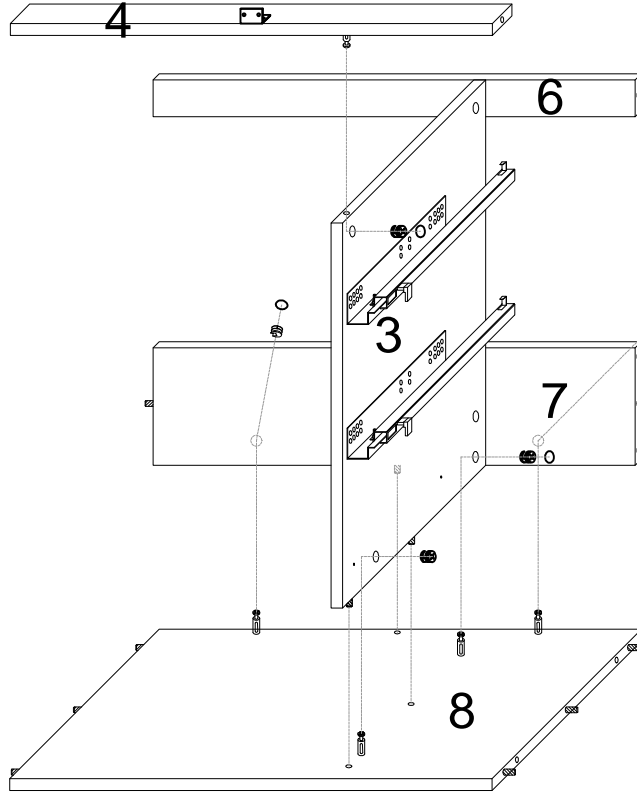
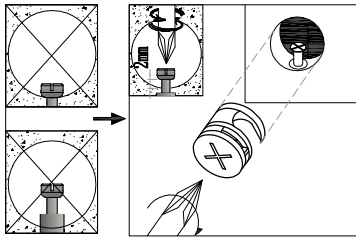

$\textcircled{3} \times 5$   
 $\textcircled{4} \times 4$

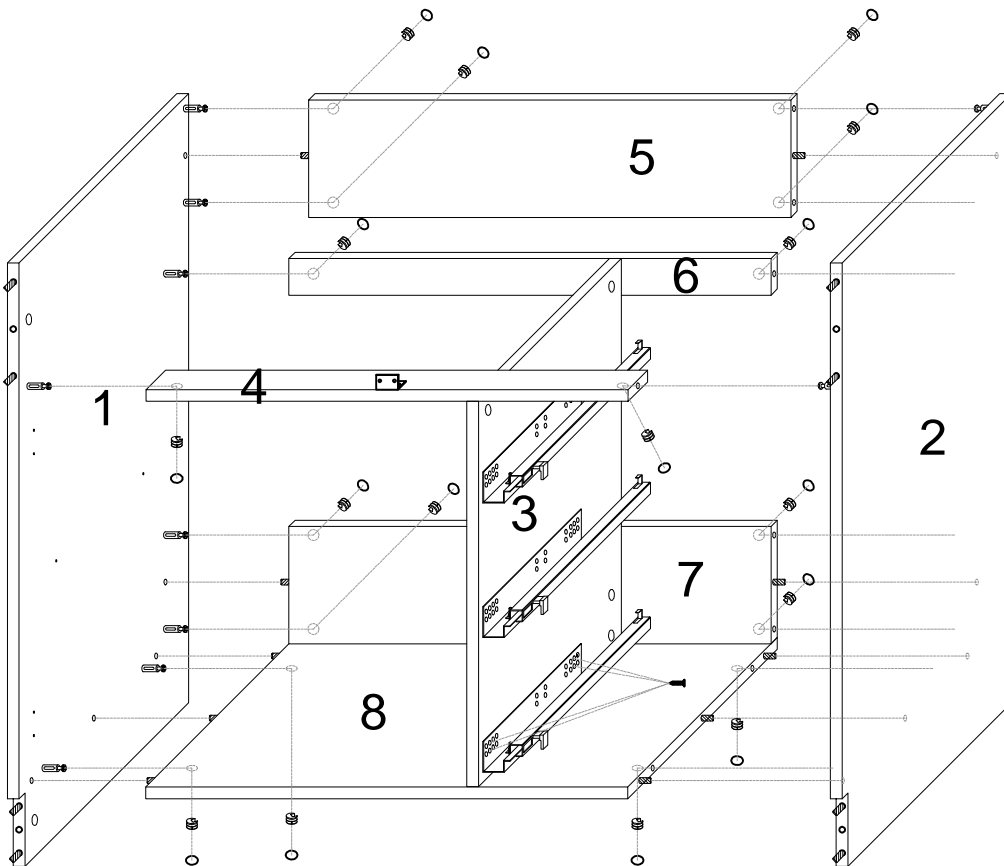

$\textcircled{3} \times 16$   
 $\textcircled{4} \times 16$   
 $\textcircled{8}L \times 1$   
 $\textcircled{7} \times 4$

# 4

③ × 4



④ × 4



⑨ × 4



M4 × 12

⑭ × 4

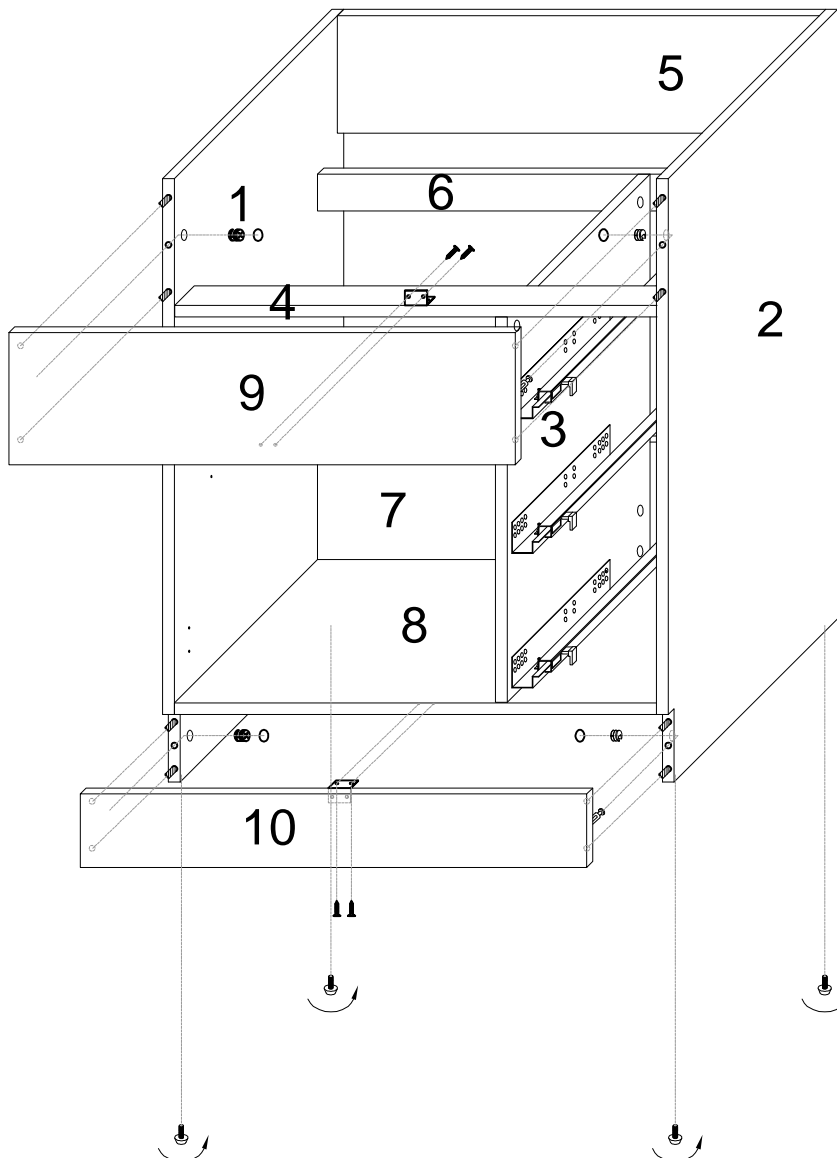
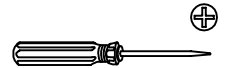

③ × 4







④ × 4

⑨ × 4

⑭ × 4

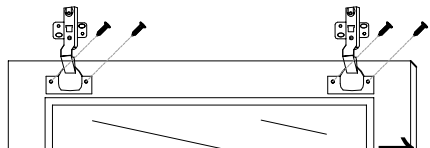

# 5

⑤ × 2 	⑥ × 2 	⑦ × 24 M4 × 14 	⑪ × 2 	⑫ × 4 
⑮ × 4 	 ⊕	⑥ × 2 ⑦ × 4		

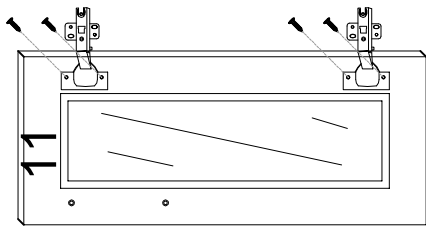



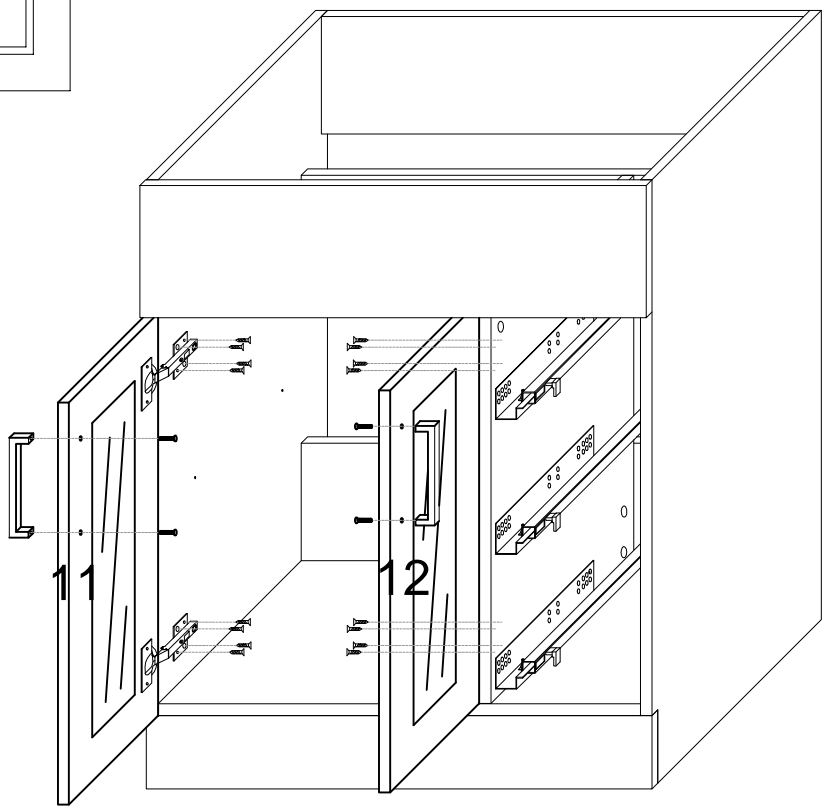

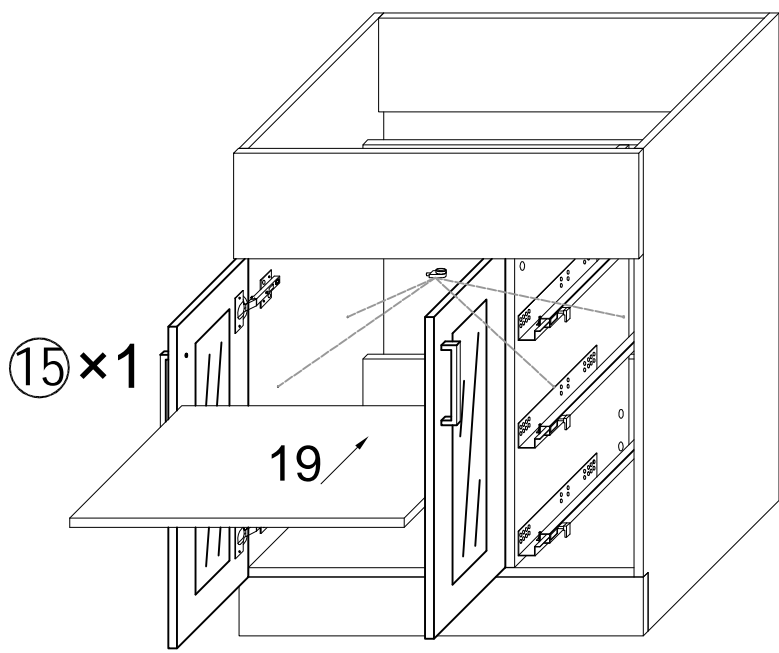
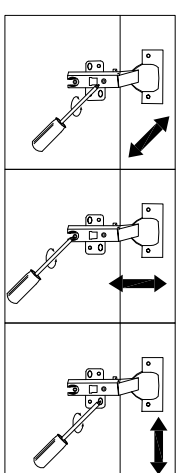

⑤ × 2  
⑦ × 4



⑦ × 16  
⑪ × 2  
⑫ × 4

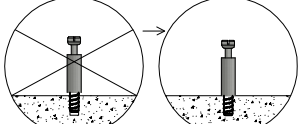

# 6

<p>② × 24</p> 	<p>③ × 24</p> 	<p>④ × 12</p> 	<p>⑪ × 3</p> 	<p>⑫ × 6</p> 
<p>⑬ × 6</p> <p>M4 × 25</p> 				

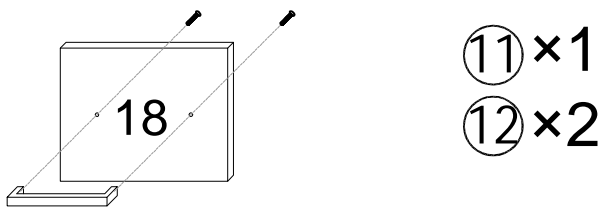
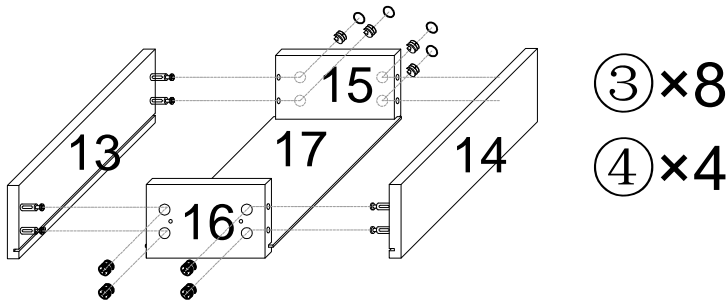
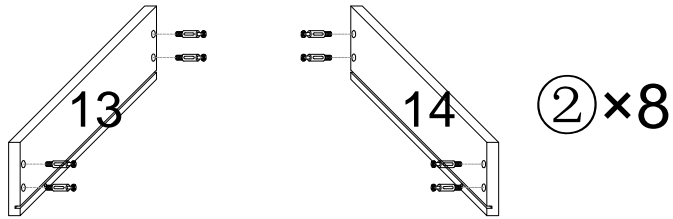

# × 3

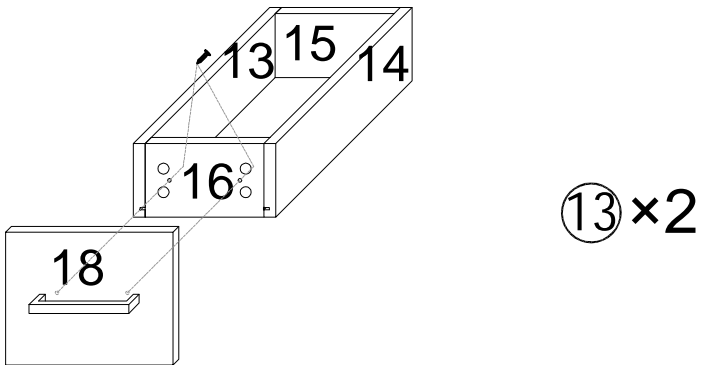

7

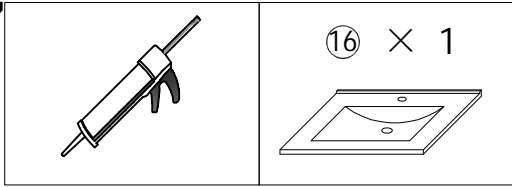

①⑥ × 1

