

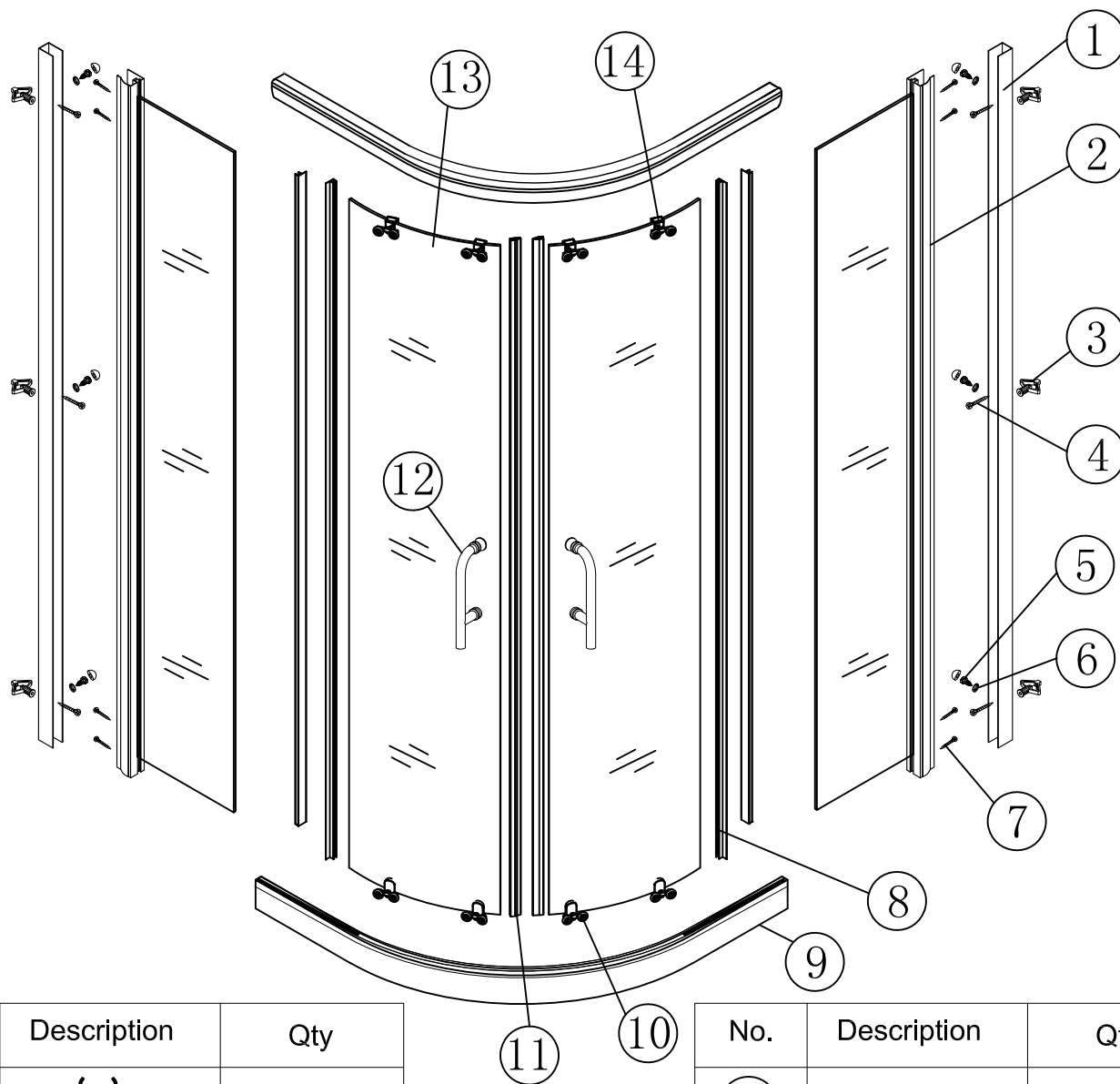













CAM Series

Installation instructions





No.	Description	Qty
①		2 PCS
②		2 PCS
③		6 PCS
④	 ST4*50	6 PCS
⑤	 ST4*12	6 PCS
⑥		6 PCS
⑦	 ST4*30	8 PCS

No.	Description	Qty
⑧		4 PCS
⑨		2 PCS
⑩		4 PCS
⑪		2 PCS
⑫		2 PCS
⑬		2 PCS
⑭		4 PCS

Tool:

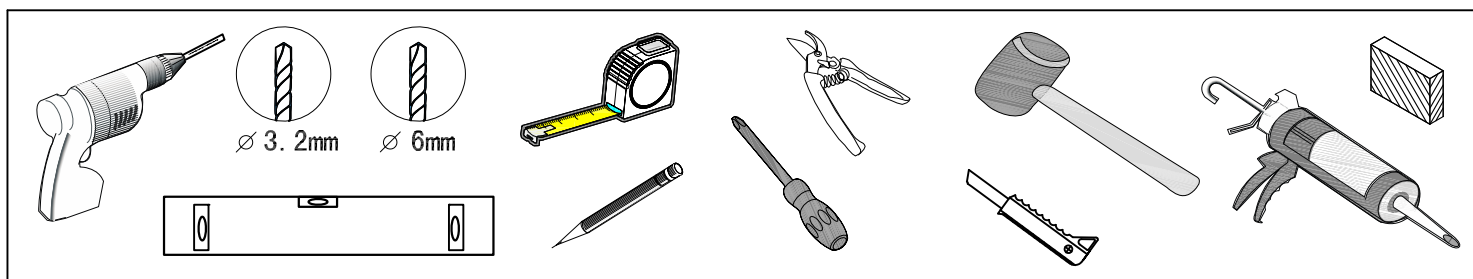

ST4*30
NO:7
8PCS

NO:2
2PCS

NO:9
2PCS

NO:1
2PCS

NO:3
6PCS

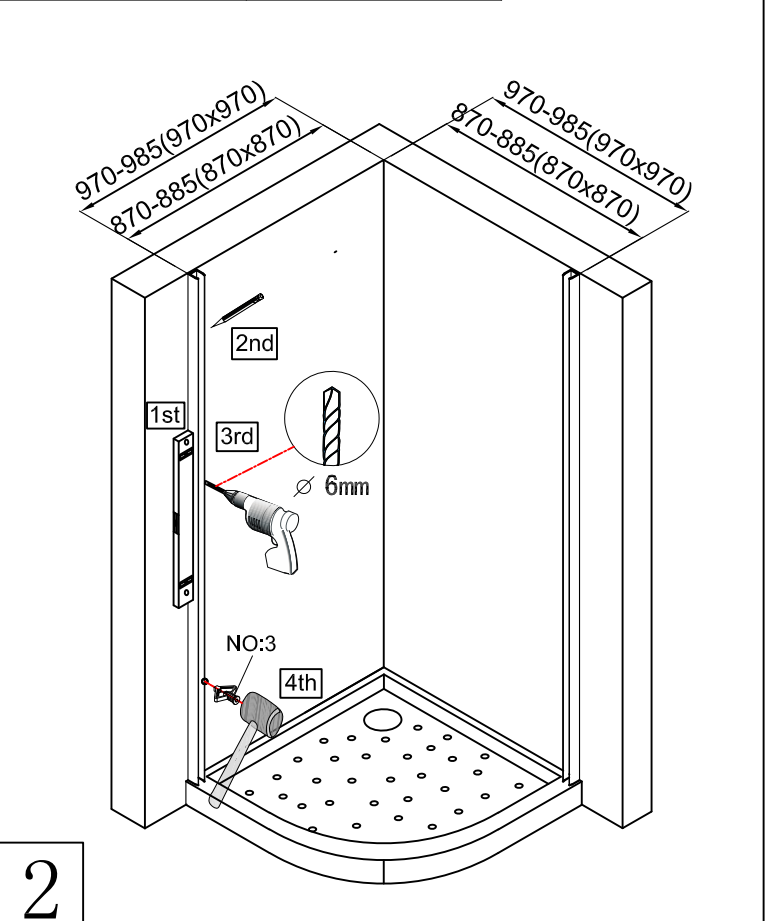
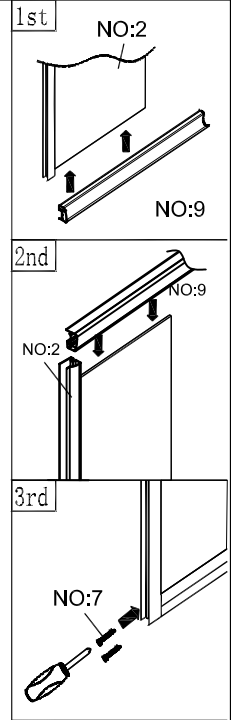
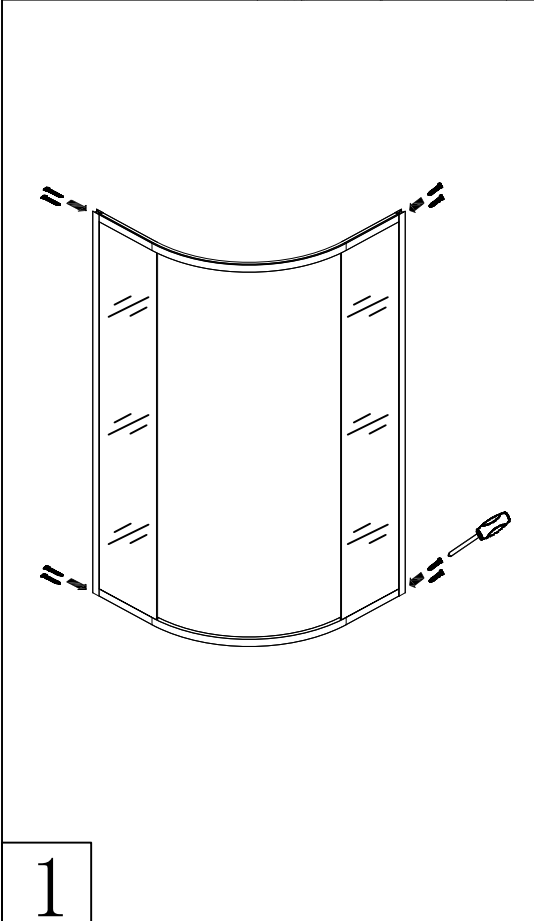

ST4*50
NO:4
6PCS

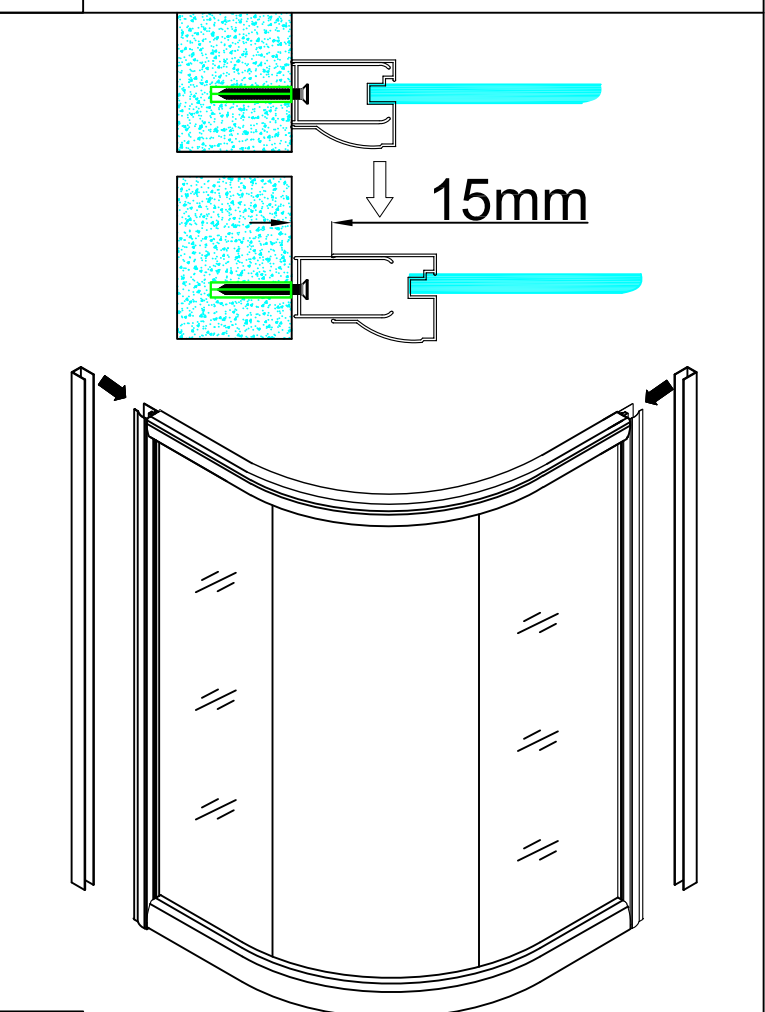
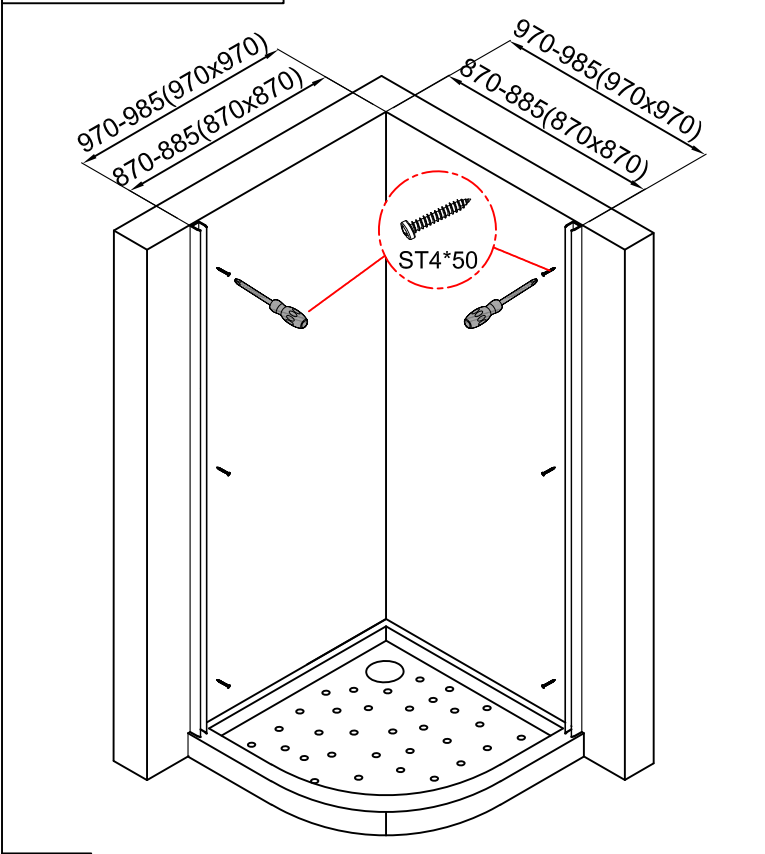

3

4

ST4*12



NO:5
6PCS

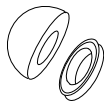

NO:6
6PCS

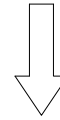
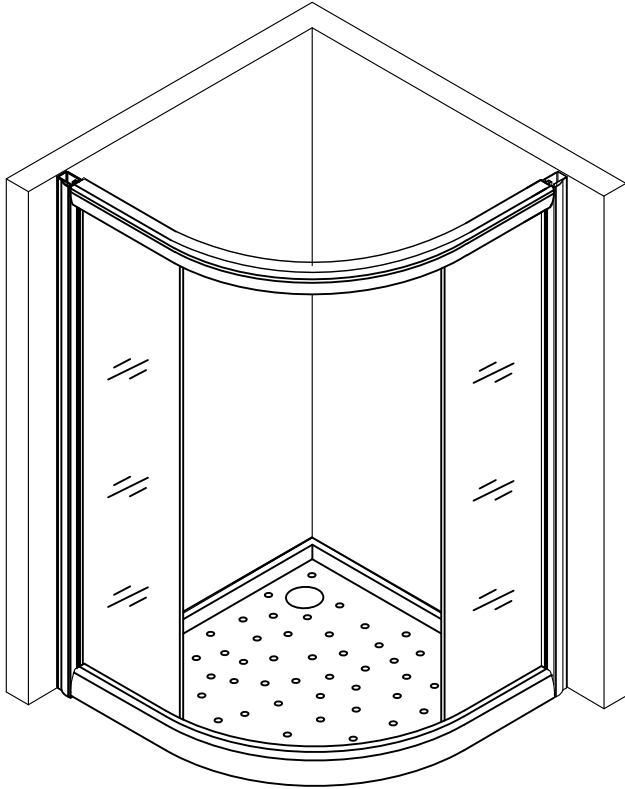

NO:6
6PCS

ST4*12
NO:5

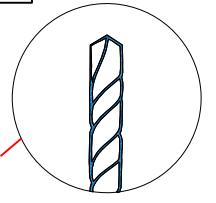
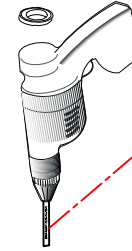

∅ 3.2mm

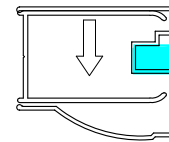

5

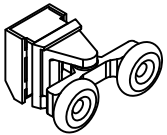

NO:14
2 PCS

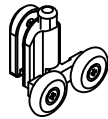

NO:10
2 PCS

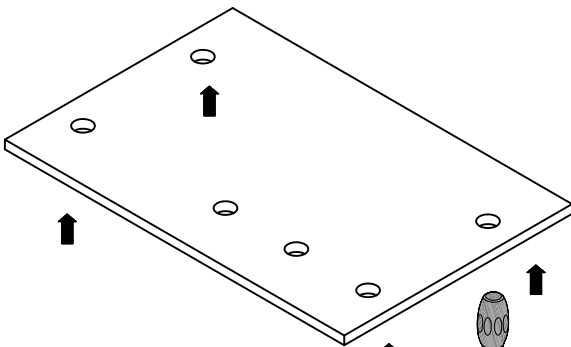
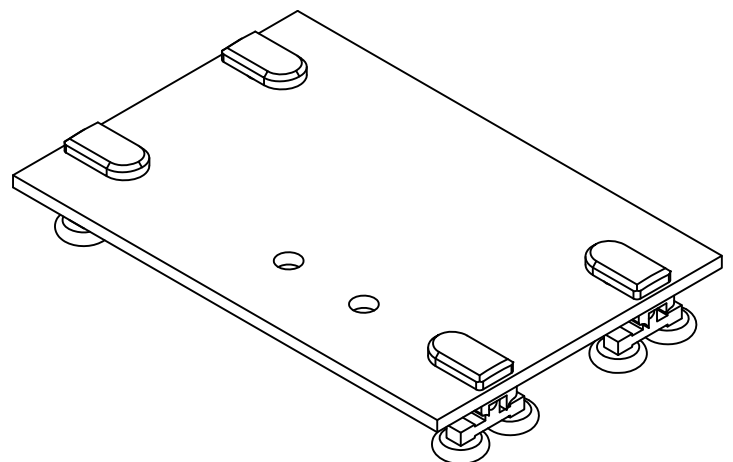
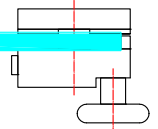
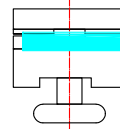

NO:14
2 PCS

NO:10
2 PCS

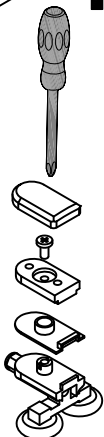

6



NO:12
2PCS

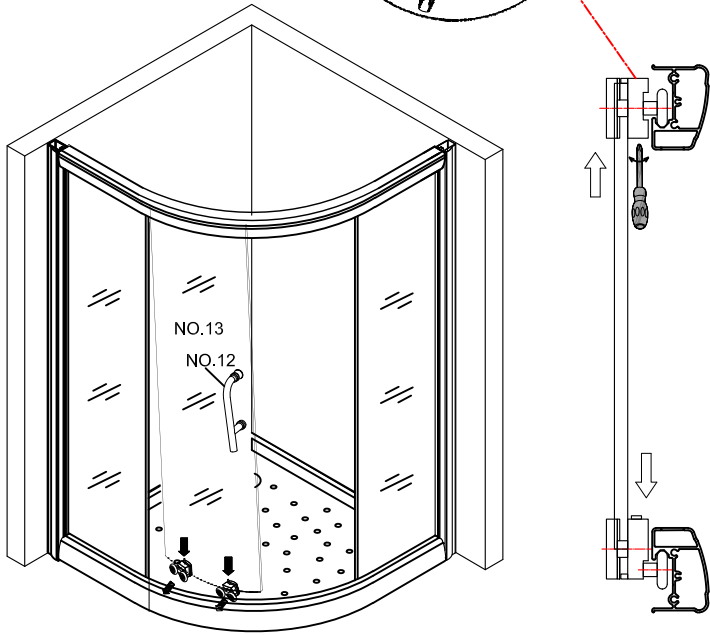
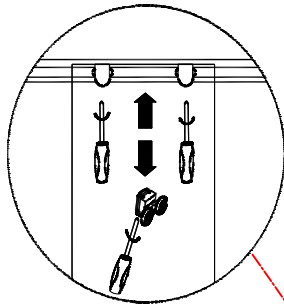

7



NO:11
2PCS



NO:8
4PCS

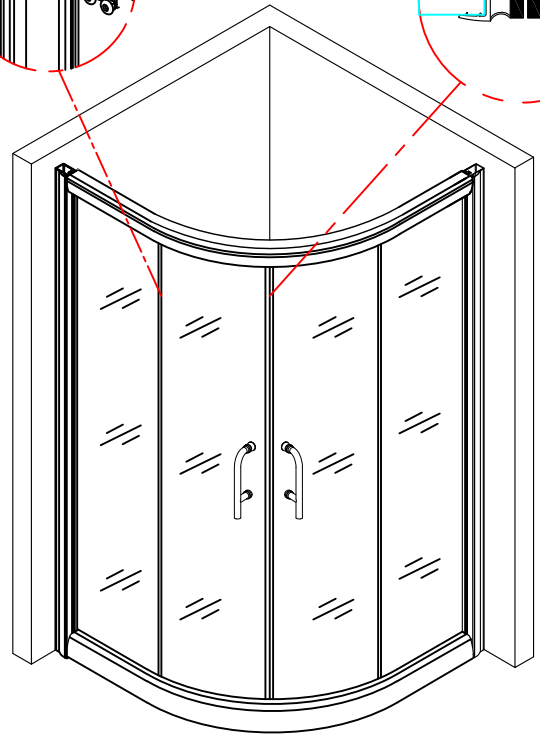
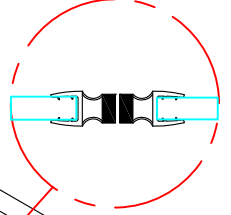
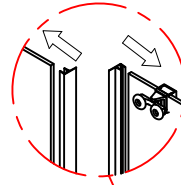

8

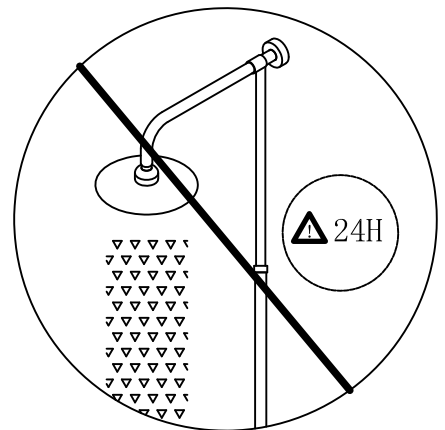
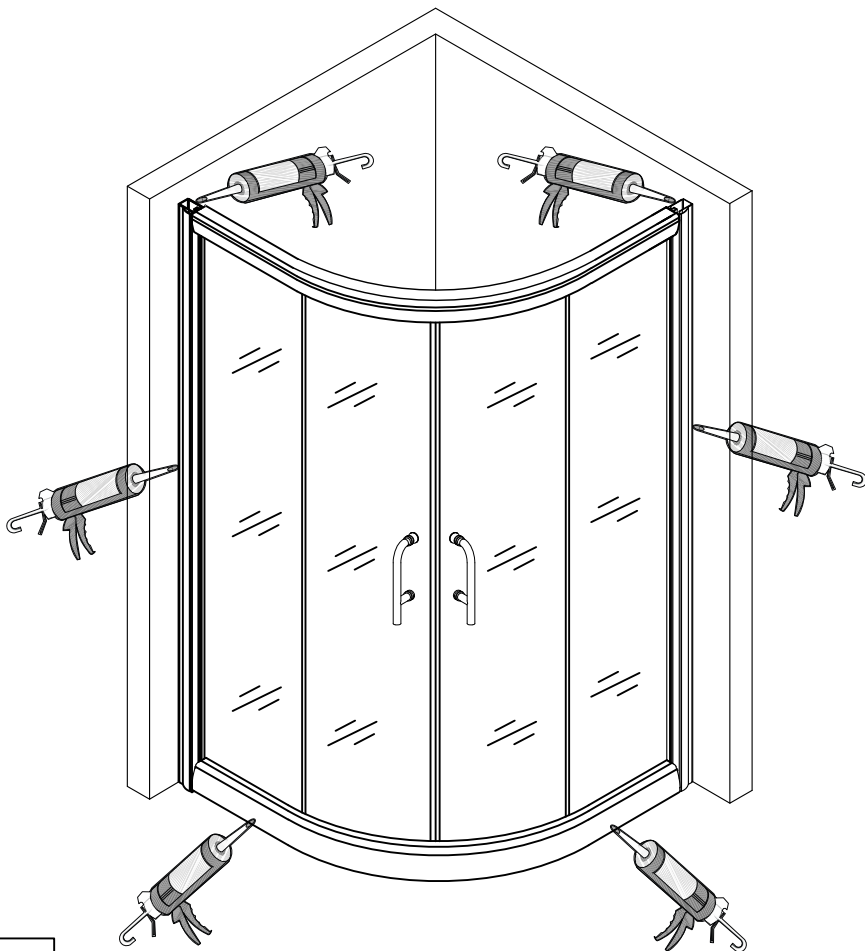

9